



e-shelf-labels

SMART.  
DIGITAL.  
EFFICIENT.

Product Catalog

# ESL MOUNTS



DISCOVER  
OUR  
ASSORTMENT!



In cooperation with METO & OVELAR

Overview

# Products

1	E-Shelf-Labels .....	04
2	Areas of Application .....	10
3	VUSION mounts - M series .....	14
4	NEWTON mounts - M series .....	26
5	NEWTON mounts - O series .....	27
6	Compatibility Overview VUSION .....	28
7	Compatibility Overview NEWTON .....	29

# Electronic price tags & labels

Digital pricing offers a cost-effective and efficient solution to facilitate quick price adjustments of products. This allows a connection between offline commerce and e-commerce. Thanks to a high degree of customisability of the labels, they are suitable for any industry and shop size and offer a reliable response to price fluctuations. This not only saves a great deal of time, but also personnel, costs and resources.

## YOUR ADVANTAGES

- fast price adjustment
- no recording errors
- actuality and time saving
- change in a few minutes
- lower power consumption
- higher customer satisfaction

## OUR MOUNTS

- Bars
- Clips
- Adapter plates
- Displays
- Additional extensions
- Other mounts
- Shelf profiles
- Hooks
- Holder
- Stand clamps
- Pedestals
- Boomerang pedestal
- Telescopic tubes
- Hanging hooks
- Angle Plug
- Newton and Vusion custom mounts

In principle, a distinction is made between the brands Vusion and Newton for electronic price signs and labels. Both brands have displays in different sizes. Each label requires a suitable and individual mount depending on the manufacturer, size and application.

## VUSION

The modular VUSION series on an e-paper basis can be customised in its layout and impresses above all with its easy installation, very good readability and up to 10 years of battery life. In addition, special versions such as the freezer models or the chemical-resistant labels are also available.

## NEWTON

The multifunctional NEWTON labels with E-Ink displays in BWR are also available in selected sizes as Freezer models and as NEWTON Lite without buttons. Lightweight and efficient, they are ideally suited for use in retail and industry.

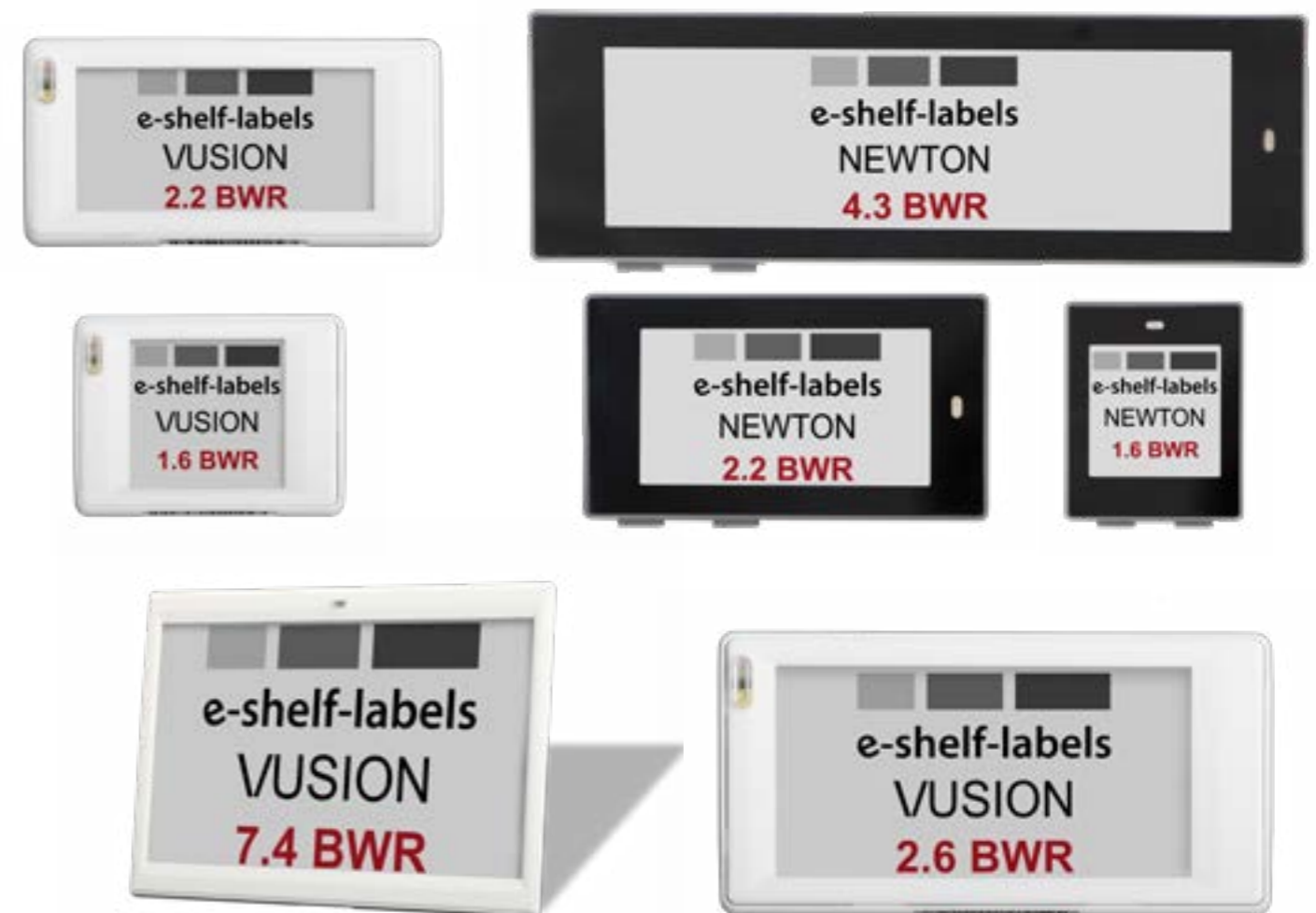

# Areas of Application

## RETAIL

Whether in construction markets, supermarkets or furniture stores, the future of price labeling is digital. Electronic labels don't just save money in the long term, they also save staff resources. As a result, employees have more time for interacting with customers and providing purchase advice.



## ROOMMANGEMENT

Electronic labels provide a flexible and safe system for room signage and reservation in offices, conference rooms and treatment rooms. This not only reduces the workload of the administration, but also guarantees error-free and clear presentation.



## INDUSTRY

Electronic labels are now facilitating important tasks in the industry. They represent flow charts, identify machines or shelves with the product they contain. This not only improves warehouse management, but also multiple processes throughout the entire process.



## HEALTHCARE

To ensure efficiency and responsiveness in medical environments, digital signage in the form of shelf labelling, room labelling and electronic labels is increasingly used. The aim is to reduce staff workload and avoid errors.



## GASTRONOMY & HOTEL

Digital signage in these industries offers a range of uses. They can be used as digital price labels for food and beverages as well as buffet signage. Uniformity, timeliness and functionality are preserved through centralised control.



## OTHER APPLICATIONS

There is a wide range of other applications. E-shelf labels are used for signage in public spaces, such as stadiums or staff transport. They are also increasingly used in the automotive industry to label cars or bicycles.



# VUSION mounts

## M series

### Bars

- Perfectly suitable for shelves
- Fixation directly in the bar
- Custom size on request
- Material: PVC
- Available colors: Transparent



### Clips

- Usage in combination with adapter plates
- Material: PC



#### Universal-bar

- Available lengths: 988 mm, 1000 mm, 1238 mm
- Roof to protect against dirt
- 15mm double sided tape



#### TLS-H-adapter

- Available lengths: 36 mm
- Attachment on existing paper rail from the bottom

#### TLS-H-bar

- Available lengths: 988 mm, 1238 mm
- Roof to protect against dirt
- Compatible with Tego / Linde / Storebest / Harres
- Adjustable in 2 positions



#### Glass-bar

- Available lengths: 1000 mm, 1250 mm
- Roof to protect against dirt
- For 4-6mm thick glass bottoms

#### Clamping-bar-adapter

- Available lengths: 54 mm
- For existing price labels
- Attachment on a 5mm wire



#### Price tag clip

- Available colors: Transparent, Black
- Adapter can be adjusted horizontally by 45°



#### Light clip

- Available color: Transparent
- Flexible hinge and small insert for adapter plates



#### Transparent clip

- Available color: Transparent
- Suitable on boxes



### Adapter plates

- Attachment on battery cover
- Material: PC
- Available color: Transparent
- Usage in combination with clips

#### Adapter plate standard



#### Adapter plate with magnet



#### Adapter plate with tape



# VUSION mounts M series

## Foot stand

- Usage as a tripod
- Usage in service counters
- Available colors: Transparent



### Single stand

- Material: PC
- Usage as a stand in combination with various adapter plates



### Foot stand small, version 1

- Material: PC
- Attachment on battery cover
- 2 pieces per ESL required



### Foot stand small, version 1

- Material: Lexan 163r
- Usage in combination with various adapter plates
- Rotation into the adapter plate



### Hangtag mount 2.2" & 2.6"

- Material: PVC
- Available colors: black
- Installation on battery compartment



## Additional extensions

### SnapOn

- Material: ABS
- Available colors: On demant
- Plugged directly on the ESL front housing
- Can be produced in various colors and be printed with text/logo

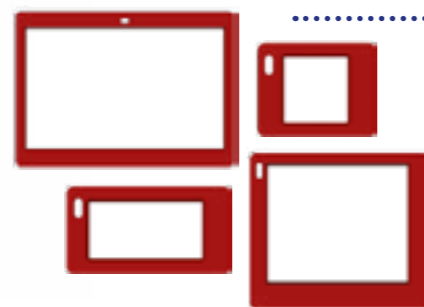

## Other mounts

### Spring bracket, telescopic

- Material: Aluminium, Stahl PETG, PA
- Available Colors: Light grey
- Strong clamp hook
- single or double-sided
- made of 1x spring holder, 2x ESL-mount, 1x pipe adapter



### Suspension hook

- Material: POM
- Available Color: Black, White
- Attachment on battery cover
- 2 pieces per ESL recommended
- For 12mm suspension



### Unifix roll

- Material: POM
- Available Color: White
- For 8-35mm thick shelves, suitable in combination
- Usage in combination with adapter plates
- 1 or 2 per ESL required

### Wall mount

- Material: PC
- Available Color: Transparent
- Versions: Standard, with tape, with magnet
- Attachment on battery cover

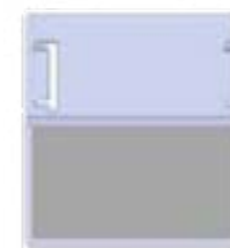

### Blisterhook / Peghook Adapter

- Material: PC
- Available Color: Transparent
- Adjustable in 3 angles with back swing mechanism
- Fits most types and brands of metal and plastic blister hooks
- Made of 2 parts: 1 part for metal hooks & and 1 part for ESL



### Clip for glass bottoms

- Material: PC
- Available Color: Transparent
- Installation on the front of glass bottoms in vertical positions
- For 3-9mm thick glass floors
- Usage in e.g. drugstores or pharmacies



# NEWTON mounts

## M series

### Bars

- Fixation directly in the bar
- Custom Size on request
- Material: PVC



### Display

- Usage on service counters
- Usage with small adapter plate
- Material: PC
- Available Color: Transparent



#### Glass bottom bar

- Available colors: Graphite black RAL 9011
- Available length: 1000 mm
- For 4-6mm thick glass bottoms



#### TLS-H bar

- Available colors: Anthracite gray RAL 7016
- Available length: 998 mm, 1238 mm
- Roof to protect against dirt
- Compatible with Tego / Linde / Storebest / Harres
- Adjustable in 2 positions



#### Universal bar M2 with tape

- Available colors: Anthracite gray RAL 7016
- Available length: 1000 mm
- Flexible front
- Clamp on the back to adjust the rail
- 15mm double-sided tape



### Clips

- Usage in combination with adapter clips and adapter plates
- Available Color: Transparent

#### Transparent clip with adjustable adapter, insert

- Material: PC
- Suitable on boxes



#### Transparent Clips

- Material: PVC, POM
- Flexible hinge and small insert for adapter plates



# NEWTON mounts

## M series

### Adapter plates

- Attachment on battery cover
- Material: PC
- Available Color: Transparent
- Usage on various standard elements
- Integrated card insert for promotions

#### Adapter plate Standard



#### Adapter plate with magnet



#### Adapter plate with tape



### Unifix roll

- Material: PVC, POM
- Available colors: Semi-transparent, White
- For 8-35mm thick shelves
- Rotation into the adapter plate
- 2 pieces per ESL required



### Other mounts

#### Blisterhook / Peghook Adapter

- Material: PC
- Available Color: Transparent
- Adjustable in 3 angles with back swing mechanism
- Fits most types and brands of metal and plastic blister hooks
- Made of 2 parts: 1 part for metal hooks & and 1 part for ESL



### Additional extensions

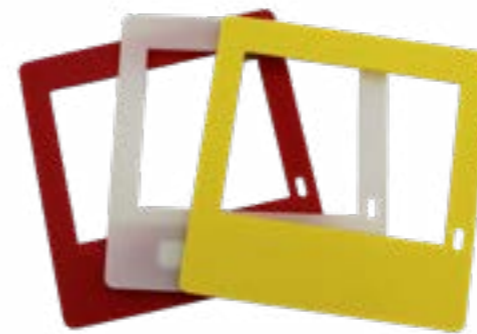

#### SnapOn Newton - for all sizes

- Material: ABS, PVC film
- Available Colors: on demand
- Plugged directly onto the ESL front housing
- Can be produced in various colors and be printed with text/logo

#### Metcool

- Material: PA 10% GF
- Available Color: Red
- Lever tool for various ESL mounts and rails



#### Tool for removing labels

- Material: Stainless steel
- Available Colors: Silver
- Lever tool for various ESL mounts and rails





# NEWTON mounts

## O series

### Shelf profile

- For attaching labels to the shelf
- Material: PVC



### Haken

- Inclination can be adjusted depending on the height of the label
- Material: Polycarbonate

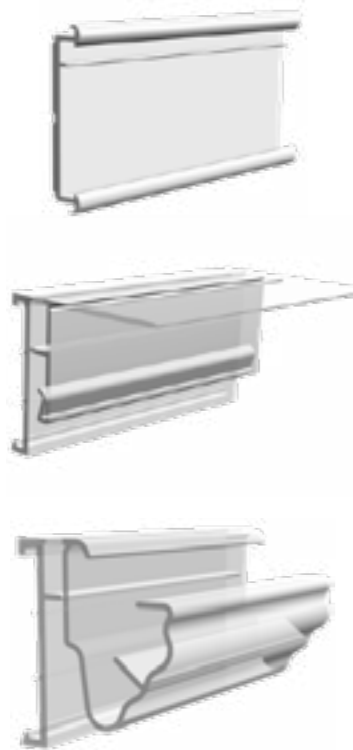

#### Shelf profile for flat front side

- Available Colors: Transparent, Black
- Available Lengths: 985mm, 1315mm

#### Shelf profile with adhesive surface and double flap

- Available Colors: Transparent, Black
- Available Lengths: 985mm, 1315mm

#### Shelf profile for Storebest, Tegometall & Linde/ Costan shelves

- Available Colors: Transparent, Black
- Available Length: 1235mm

#### Shelf profile with adhesive surface

- Available Colors: Transparent, Black
- Available Lengths: 985mm, 1315mm

#### Shelf profile for T-bars

- Available Colors: Transparent
- For attaching to „T“-hooks and to the shelf

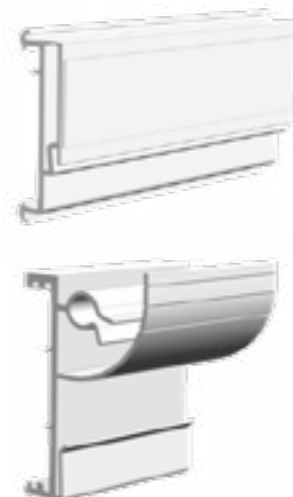

#### Cho cross hook model with three degrees of inclination

- Available color: Transparent
- For Ø 3 to 6 mm and Ø 5 to 8 mm rods
- Requires T-hook attachment: Suitable for short upper, axial or lower bar hook rod

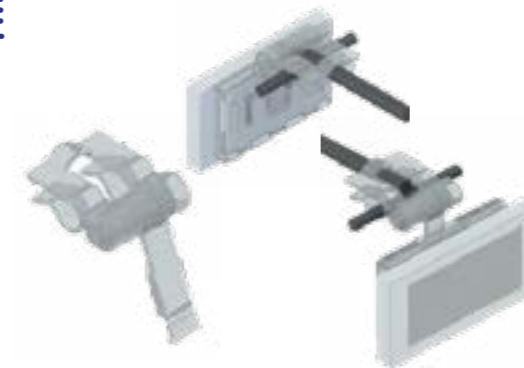

#### Hook with universal OVL model

- Available color: Transparent
- Benötigt T-Haken-Befestigung: Passend für kurze obere, axiale oder untere Stangenhaken Stange



#### Single sided hook

- Available color: Crystall
- Hook for hanging SOLUM 11.6" from hanging rails
- Compatible with bracket and hook for SOLUM 11.6"



#### Bracket & hook for SOLUM 11.6"

- Material: ABS, Polycarbonate
- Available colors: Gray, Crystal
- For hanging on overhead rail



# NEWTON mounts

## O series

### Adapter plates

Material: Polycarbonate  
Available Color: Transparent



Adapter plate 1.6" .....

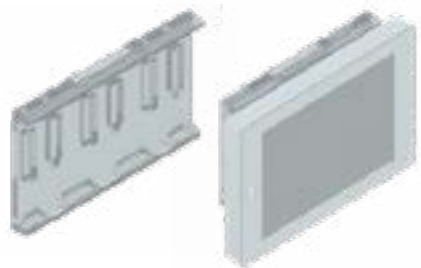

Adapter plate 2.2", 2.6" & 2.7" .....

Adapter plate 2.9" .....

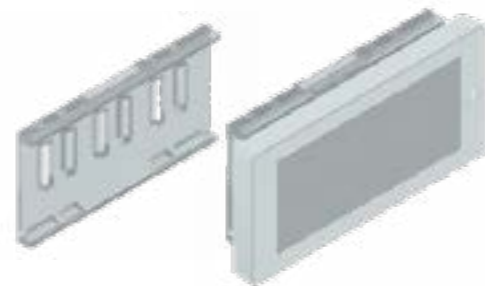

Adapter plate 4.2" .....

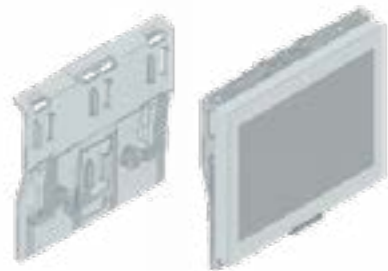

Inclined brace 4.2" .....

Adapter plate 4.3", 6.0" & 7.5" .....

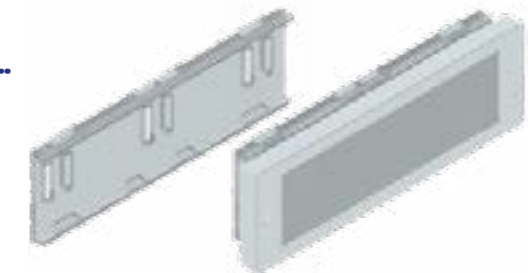

Adapter plate 6.0" .....

Adapter plate 7.5" .....



Adapter plate SOLUM  
Button Label .....

# NEWTON mounts

## O series

### Mounts and more adapter

- Compatible with all label sizes up to 7.5"
- Usage with adapter plates



### Pedestal

- Individual adjustment of the inclination depending on the height of the label



#### Magnet holder

- Material: Acetal
- Available Color: Gray
- 2mm neodymium magnet

#### Hanging adapter

- Material: Polycarbonate
- Available Color: Transparent
- Wire or cable

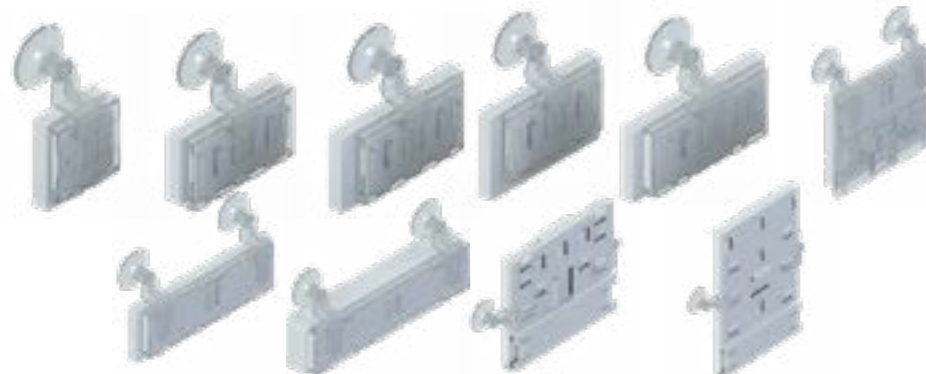
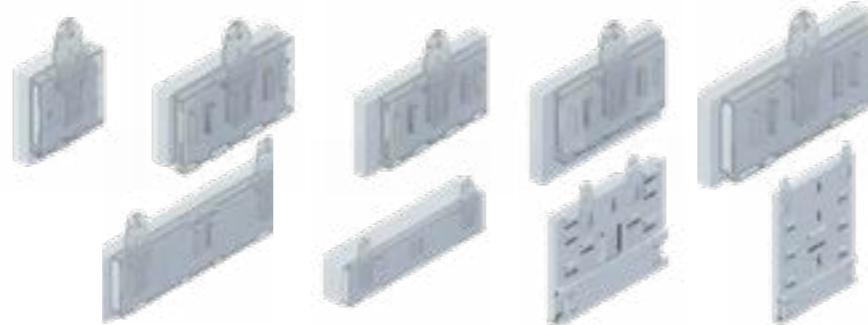

#### Suction pad mount

- Material: Polycarbonate
- Available Color: Crystal
- Wire or cable

#### Pedestal inclined

- Material: Polycarbonate, ABS
- Available Colors: Crystal, Gray
- Label attachment in horizontal or vertical position



#### Pedestal for double connection rods

- Material: Polycarbonate
- Available Colors: Crystal, Black
- Small für SOLUM 1.6", 2.2", 2.6", 2.7", 2.9" & 4.2"
- Medium für SOLUM 4.2" 4.3", Button Label & 6.0"
- Compatible with double connection rods and adapter plates

#### Pedestal with adjustable inclination

- Material: Polycarbonate
- Available Color: Crystal
- For SOLUM 1.6", 2.2", 2.6", 2.7" & 2.9"
- Compatible with adapter plates



### Boomerang pedestal

#### 35mm

- Material: Polycarbonate, Acetal
- Available Colors: Crystal, Black
- For SOLUM 1.6", 2.2", 2.6", 2.7" & 2.9"
- Compatible with adapter plates



#### 55mm

- Material: Polycarbonate, Acetal
- Available Colors: Crystal, Black
- For SOLUM 1.6", 2.2", 2.6", 2.7" & 2.9"
- Compatible with adapter plates



#### 110mm

- Material: Polycarbonate, Acetal
- Available Colors: Crystal, Black
- For SOLUM 1.6", 2.2", 2.6", 2.7", 2.9" & 4.2"
- Compatible with adapter plates



# NEWTON mounts

## O series

### Clips

- Compatible with adapter plates



#### Clip for rods

- Material: Acetal
- Available Colors: Black, White
- Available sizes: Ø 5 mm, Ø 10 mm, Ø 15 mm, Ø 30 mm



#### Clip for rods and rod holders from Ø 4 to 6 mm

- Material: Polystyrene
- Available Color: Crystal
- 6mm middle cut

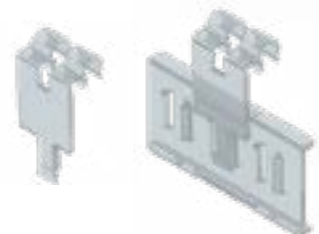

#### Clip for shelves from 8 to 15 mm

- Material: Polycarbonate
- Available Color: Crystal
- Available for upper and lower position

#### Universal Clip

- Material: Polycarbonate
- Available Color: Crystal
- For 5 to 30mm thick floors



#### Clip for glass bottoms with non-slip rubber

- Material: Polycarbonate
- Available Color: Crystal
- Available sizes: For 8 mm shelves, For 10 mm shelves
- Anti-slip rubber coating for safe grip

#### Universal swivel clip

- Material: Polycarbonate
- Available Color: Crystal
- For up to 10mm thick floors

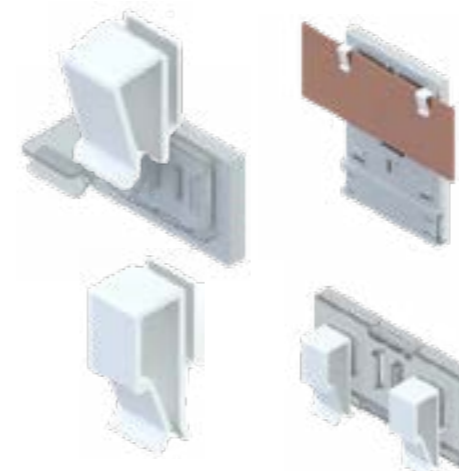

#### Clip for edges from 1 to 6 mm

- Material: Acetal
- Available Colors: White, Black

#### Clip for edges from 1 to 12 mm

- Material: Acetal
- Available Colors: White, Black

### Telescopic tube

- Compatible with bracket & hook for SOLUM 11.6"

#### Telescopic tube with extendable rod from 1000 to 1900mm

- Material: Aluminium
- Available Color: Anodized



#### Telescopic tube with stand for SOLUM 11.6"

- Material: Aluminium / Metal
- Available Colors: Anodized / RAL 9006
- Total mount for NEWTON 11.6"



#### Stand for telescopic tube

- Material: Metal
- Available Color: RAL 9006
- Available sizes: 160 x 200 mm  
Ø 240 mm



# NEWTON mounts

## O series

### Hanging hook

- Compatible with adapter plates



#### Hanging hook

- Material: Polycarbonate
- Available Color: Crystal
- 9mm connection

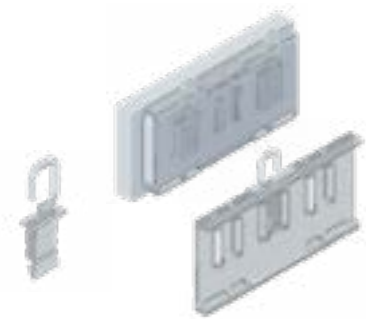

#### Hanging hook for rods up to Ø 20 mm

- Material: Polycarbonate
- Available Color: Crystal
- 9mm connection

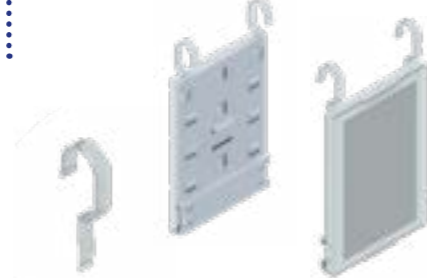

#### Hanging hook for Ø 8 mm

- Material: Polycarbonate, Acetal
- Available Colors: Crystal, Black
- Compatible with all label sizes up to 7.5"

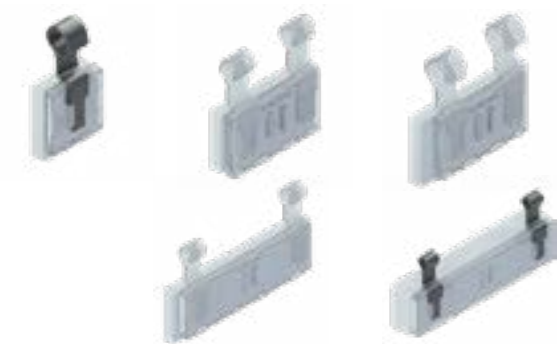

#### Hanging hook for Ø 12 mm

- Material: Polycarbonate, Acetal
- Available Colors: Crystal, Black
- Compatible with all label sizes up to 7.5"



### Angle plug

- Material: Acetal
- Available Colors: Black, White
- Provides various inclination angles for accessories
- Essential for attaching to stand clips, double connection, rods, omni-clippers, uni-clippers or clips for boxes and baskets



### Angle plug & clamps



#### Stand clamp for inclination adjustment

- Material: Acetal
- Available Colors: Black, White
- For SOLUM 1.6", 2.2", 2.6", 2.7", 2.9" UND 4.2"
- Angle plug required (not included)



#### Stand clamp for inclination adjustment for SOLUM 6.0" und 7.5"

- Material: Acetal
- Available Colors: Black, White
- Angle plug required (not included)

### Clamp with double hinge

- Material: Polycarbonate
- Available Color: Black
- Compatible with adapter plates



# NEWTON & VUSION

## Custom mounts

Custom mounts in various colors or shapes are also available on request. These mounts are discussed individually with METO and Ovelar and charged according to the effort involved. Please contact us to receive an individual offer for special mounts.



### Special mount for bicycles

- Material: PVC
- Available Colors: Black
- Specially designed for safe attachment to bicycle handlebars



# VUSION

## compatibility

	1.6"	2.2"	2.6"	4.2"	4.5"	7.4"	9.7"	12.2"
Blisterhook/Peghook	X	X	X		X			
Universal bar	X	X	X		X			
Glass bar	X	X	X		X			
Clip for glass bottoms	X	X	X		X			
TLS-H bar	X	X	X		X			
TLS-H adapter	X	X	X		X			
Clamping bar adapter	X	X	X		X			
Suspension hook	X	X	X	X	X	X	X	
Foot stand small 1	X	X	X		X			
Foot stand small 2				X		X	X	
Single stand			X	X	X			
Adapter plate small	X	X	X	X	X	X	X	
Adapter plate large				X		X	X	
Wall mount								X
Transparent clip				X	X	X	X	
Light clip	X	X	X					
Price tag clip				X		X	X	
Unifix roll	X	X	X	X	X	X	X	
Spring bracket								X
SnapOn	X	X	X	X	X	X	X	
Hangtag mount		X	X					

# NEWTON

## compatibility

	1.6"	2.2"	2.6"	2.7"	2.9"	4.2"	4.3"	6.0"	7.5"	11.6"
Blisterhook/Peghook	X	X	X	X	X					
Glass bottom bar	X	X	X	X	X	X	X			
TLS-H bar	X	X	X	X	X	X	X			
Universal bar	X	X	X	X	X	X	X			
Single display 5 cm	X	X	X	X	X					
Single display 10 cm						X	X	X		
Adapter plate small	X	X	X	X	X	X	X	X	X	
Adapter plate large						X		X	X	
Transparent clip						X	X	X	X	
Transparent clip 2	X	X	X	X	X					
Unifix roll	X	X	X	X	X	X	X	X	X	
Foot stand small	X	X	X	X	X	X	X	X	X	
Shelf profile flat	X	X	X	X	X	X	X			
Shelf profile adhesive surface & double flap	X	X	X	X	X	X	X			
Shelf profile adhesive surface	X	X	X	X	X	X	X			
Shelf profile Storebest	X	X	X	X	X	X	X			
Shelf profile T-bars	X	X	X	X	X	X	X			
Adapter plate 1.6"	X									
Adapter plate 2.2", 2.6" & 2.7"		X	X	X						
Adapter plate 2.9"					X					
Adapter plate 4.2"						X				
Inclined brace 4.2"						X				
Adapter plate 4.3", 6.0" & 7.5"							X	X	X	
Adapter plate 6.0"								X		
Adapter plate 7.5"									X	
Cho cross hook	X	X	X	X	X					
Hook OVL model	X	X	X	X	X					

	1.6"	2.2"	2.6"	2.7"	2.9"	4.2"	4.3"	6.0"	7.5"	11.6"
Magnet holder	X	X	X	X	X	X	X	X	X	X
Hanging adapter	X	X	X	X	X	X	X	X	X	X
Suction pad mount	X	X	X	X	X	X	X	X	X	X
Hanging hook for Ø 8 mm & Ø 12 mm	X	X	X	X	X	X	X	X	X	X
Pedestal inclined						X	X	X	X	
Boomerang pedestal 35 mm	X	X	X							
Boomerang pedestal 55 mm		X	X	X	X					
Boomerang pedestal 110 mm		X	X	X	X					
Pedestal for connection rods				X	X	X	X			
Pedestal adjustable inclination	X	X	X	X						
Angle plug	X	X	X	X	X	X	X	X	X	
Single sided hook	X	X	X	X	X	X	X	X	X	
Stand clamp 1	X	X	X	X	X	X				
Stand clamp 2								X	X	
Clip for edges	X	X	X	X	X	X	X	X	X	
Clip for rods	X	X	X	X	X	X	X	X	X	
Clip for rods and rod holders	X	X	X	X	X	X	X	X	X	
Clip for shelves	X	X	X	X	X	X	X	X	X	
Clip for glass bottoms	X	X	X	X	X	X	X	X	X	
Universal clip	X	X	X	X	X	X	X	X	X	
Universal swivel clip	X	X	X	X	X	X	X	X	X	
Hanging hook	X	X	X	X	X	X	X	X	X	
Clamp double hinge	X	X	X	X	X	X	X	X	X	
Stand & telescopic tube										X

A brand of



solutions

## Smart. Digital. Efficient.

---

### e-shelf-labels S&K Solutions GmbH

 Sailerwöhr 16, 94032 Passau  
 +49 851 200930-30  
 +49 851 200930-22  
 info@sk-solutions.com | info@e-shelf-labels.com  
 www.sk-solutions.com | www.e-shelf-labels.com





---

### e-shelf-labels Hungary

 Futó utca 35-37, 1082 Budapest  
 +36 7061 58 001  
 info@e-shelf-labels.hu  
 www.e-shelf-labels.hu

---

### e-shelf-labels Czech republic

 Impact Hub Brno, Cyrilská 7, 60200 Brno  
 +420 734 115 584  
 info@e-shelf-labels.cz  
 www.e-shelf-labels.cz

---

### e-shelf-labels Poland

 ul. Strefowa 25, 58-200 Dzierżoniów  
 +48 735 379 638  
 info@e-shelf-labels.pl  
 www.e-shelf-labels.pl